

Свързването и поддръжката на осветителното тяло трябва да се извършват само от обучен и квалифициран персонал, в съответствие с действащото законодателство.

Connection and maintenance of the luminaire must be carried out by trained and qualified staff only, in compliance with the regulation in force.

Уверете се, че няма никакво захранване, свързано с устройството, преди да извършите каквото и да било техническо обслужване.

Make sure there is no power connected to the fitting before carrying out any maintenance.

Безопасността се осигурява само при правилно използване на следните инструкции, така че трябва да ги пазите.

Safety ensured only with the appropriate use of the following instructions, so you must keep them.

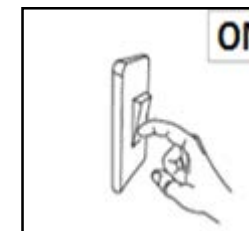
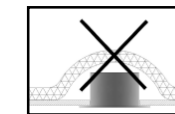
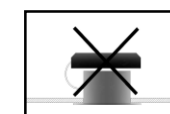
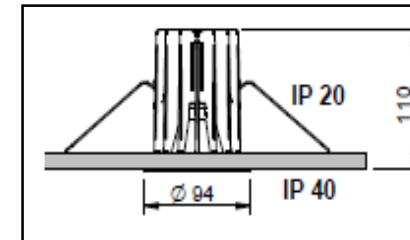
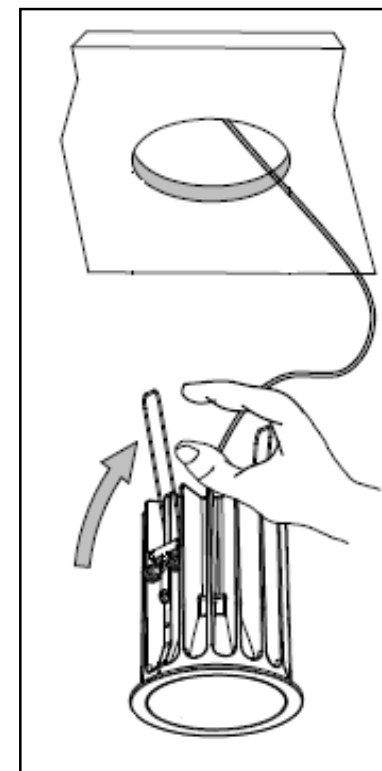
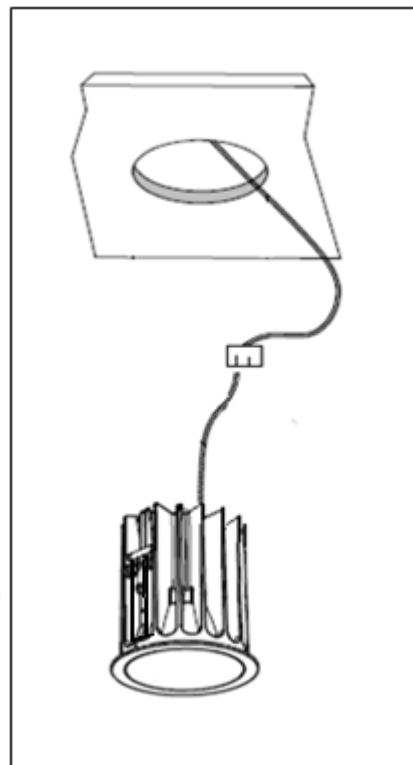
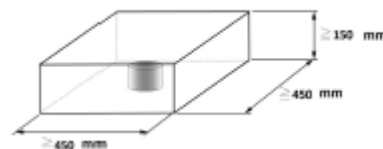
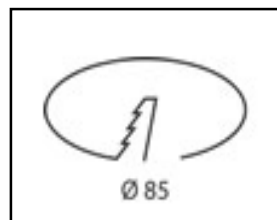
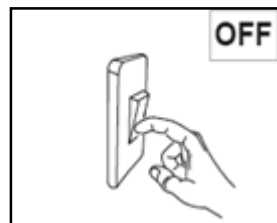

Свързването и поддръжката на осветителното тяло трябва да се извършват само от обучен и квалифициран персонал, в съответствие с действащото законодателство.

Connection and maintenance of the luminaire must be carried out by trained and qualified staff only, in compliance with the regulation in force.

Уверете се, че няма никакво захранване, свързано с устройството, преди да извършите каквото и да било техническо обслужване.

Make sure there is no power connected to the fitting before carrying out any maintenance.

Безопасността се осигурява само при правилно използване на следните инструкции, така че трябва да ги пазите.

Safety ensured only with the appropriate use of the following instructions, so you must keep them.

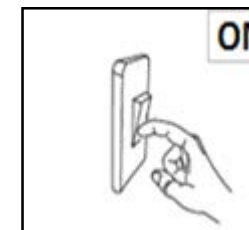
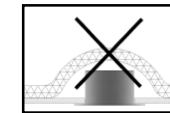
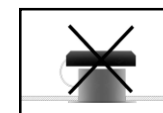
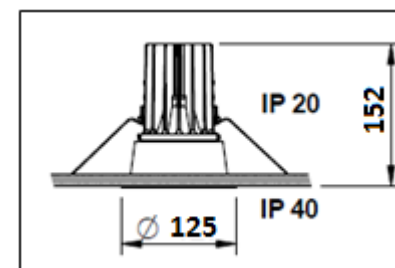
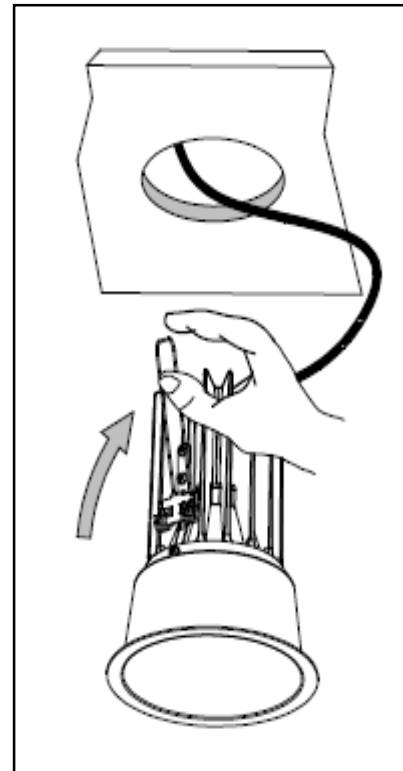
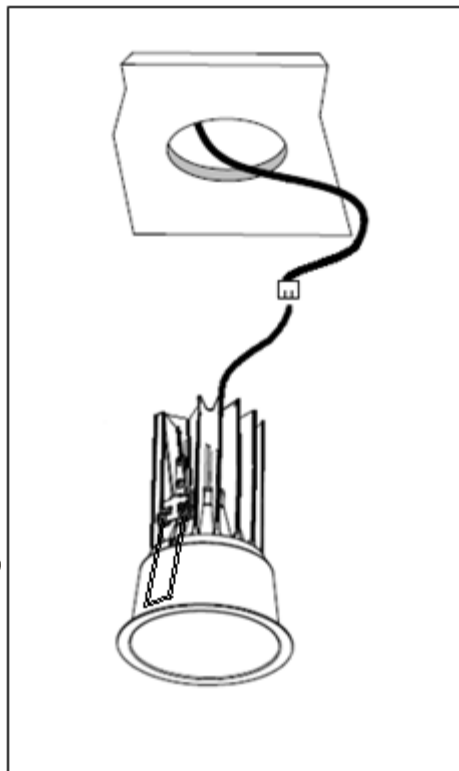
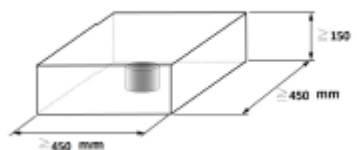
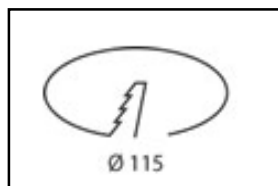
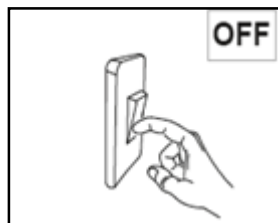

Свързването и поддръжката на осветителното тяло трябва да се извършват само от обучен и квалифициран персонал, в съответствие с действащото законодателство.

Connection and maintenance of the luminaire must be carried out by trained and qualified staff only, in compliance with the regulation in force.

Уверете се, че няма никакво захранване, свързано с устройството, преди да извършите каквото и да било техническо обслужване.

Make sure there is no power connected to the fitting before carrying out any maintenance.

Безопасността се осигурява само при правилно използване на следните инструкции, така че трябва да ги пазите.

Safety ensured only with the appropriate use of the following instructions, so you must keep them.

